

Installation Instructions

600DW

Typical Installation

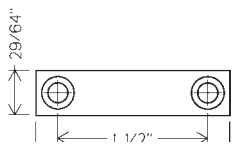
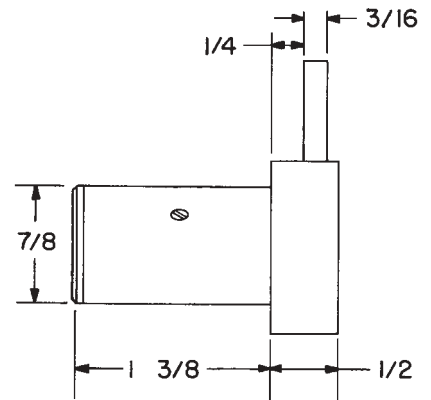
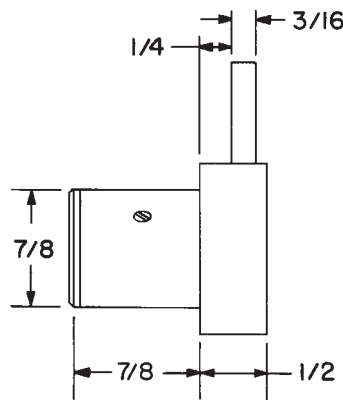
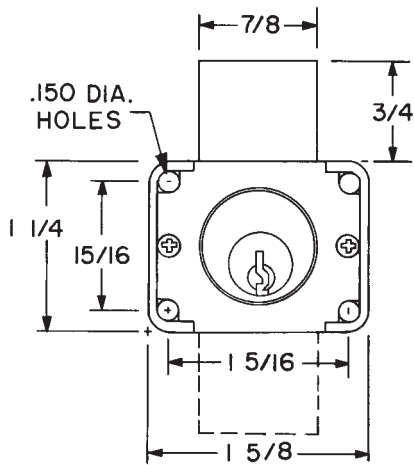
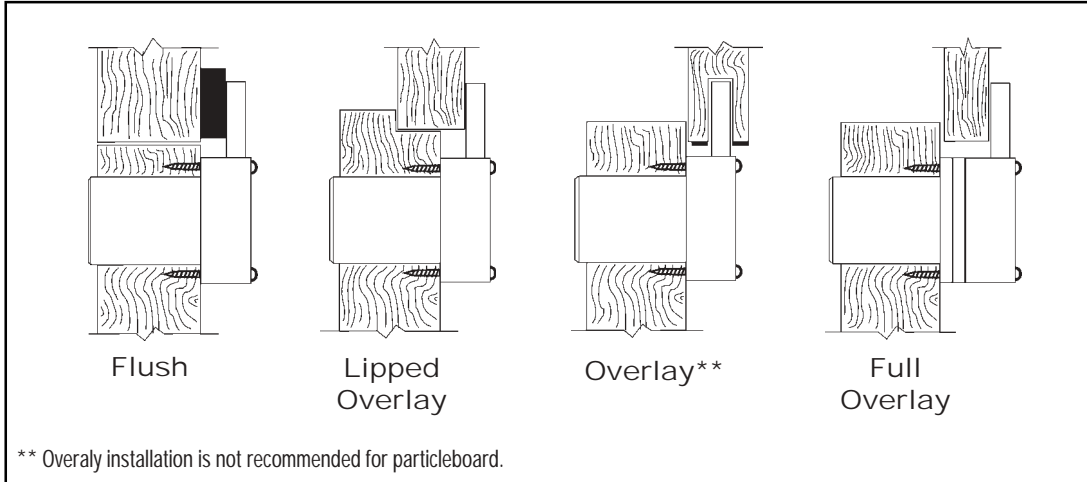

56-1 - bar strike

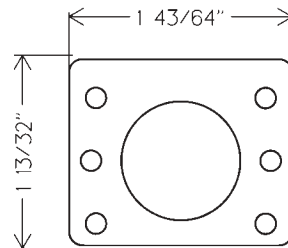
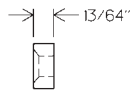

WP21 - $3/32$ " spacer

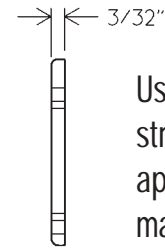

Use of spacers and strikes depends on application and material thickness.

Title Installation instructions for 600DW series cabinet drawer lock				
Series 600DW	Barrel Length 7/8" or 1-3/8"	Bolt type Deadbolt	Mounting Surface	Revision Date 06/2004

