

Installation Instructions

996

Typical Installation

IMPORTANT note for lock installation:

Be sure and position barrel/cylinder and bolt for desired handing *before* drilling hole for lock. The position of the barrel/cylinder relative to the lock body is different for each or the four available handings. It is critical to configure the lock for the correct handing before starting installation.

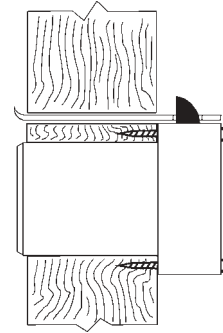
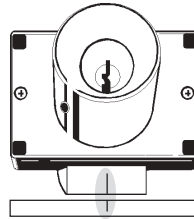
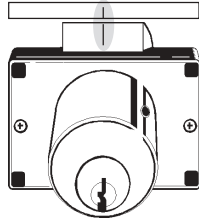

Strike installation: Line up center mark on latch with center mark on strike for correct strike placement.

996V - Vertical Hand (VH)

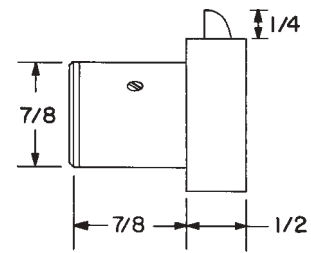
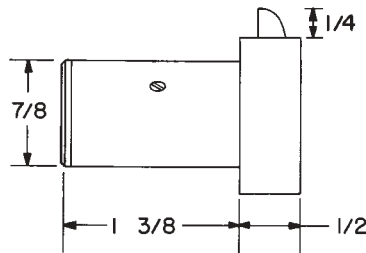
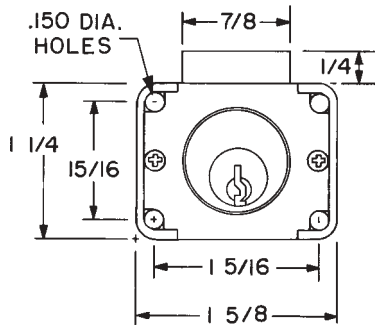

996I - Inverted Hand (IH)

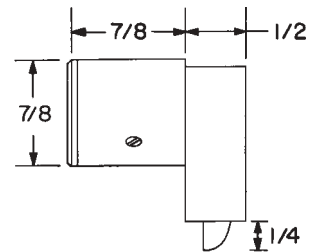
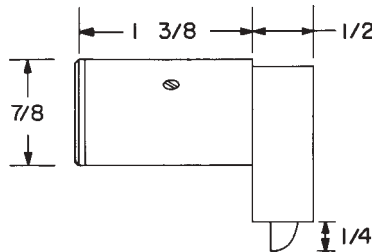
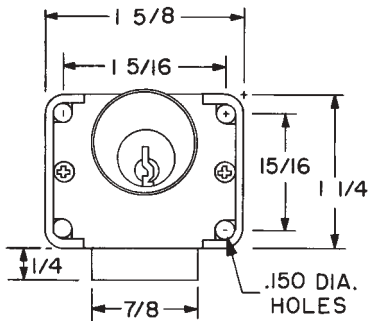

Title

Installation instructions for 996 series cabinet drawer lock

Series

996

Barrel Length

7/8" or 1-3/8"

Bolt type

Latch

Mounting

Surface

Revision Date

06/2004

OLYMPUS
LOCK, INC.