

# Product

# 2000LP Series

ADA Compatible Integrated  
Handle and Cabinet Lock



U.S. Patent No.  
6,412,317 B1

## Meets ADA Standards\*



\* Meets ADA standards when  
used with optional wire pull.



For 1-1/8" diameter, large  
pin cabinet locks

"I applaud your research toward a beneficial solution to all users, including people with disabilities," and for "creating a system that would not only meet the required code and ADA standards, but would truly work the best for the widest range of users."

*Barbara L. Allan,  
Director Access/Abilities Program, Easter Seals*

### OVERLAY CONSTRUCTION For door or drawer applications

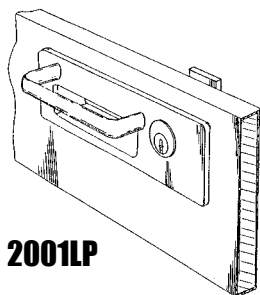

2001LP

### FLUSH CONSTRUCTION For door or drawer applica-

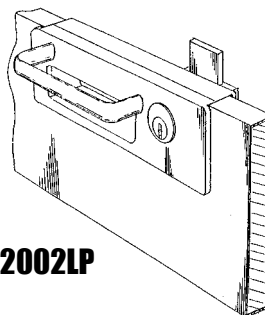

2002LP

### DRAWER LINER CONSTRUCTION For drawer applications

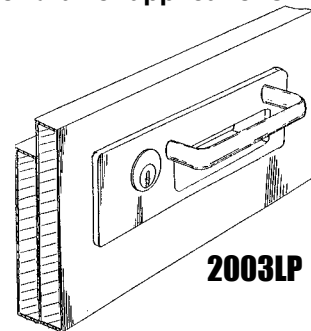

2003LP

**OLYMPUS**  
**LOCK, INC.**

*The cabinet lock innovators.*

18424 Highway 99 • Lynnwood, WA 98037  
Phone 206-362-3290 • Toll-free 800-525-0954 • Fax 206-362-3569  
www.olympus-lock.com • info@olympus-lock.com

Data Sheet

# 2000LP SERIES

## ADA Compatible Integrated Handle and Cabinet Lock



### General Specifications

#### 2000LP Series Handles

- Accepts Olympus #700, #800, #721, #754, #854, #777, #888 or #931 series 1-1/8" diameter cabinet door and drawer locks.
- Compatible for use in ADA (American Disabilities Act) applications.
- Fits door (LH or RH) and drawer applications.
- Available in US3 or 26D finish.
- Locks available keyed alike, keyed different or custom keyed to your specifications.
- Sold with optional wire pull if needed.
- Easy to install - just cut a notch or hole out of the door or drawer, insert unit, and use screws to tighten in place.
- Matching dummy handles for non-locking doors and drawers.

#### 2000LP LARGE PIN HANDLE DIMENSIONS

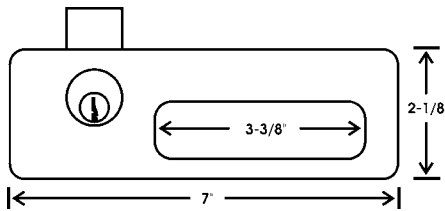

#### OVERLAY CONSTRUCTION

For door or drawer applications

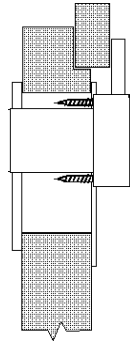

**2001LP** - Locking handle  
**2001LPD** - Dummy handle

- Fits 3/4" to 1" material thickness
- Available RH or LH door and drawer

#### FLUSH CONSTRUCTION

For door or drawer applications

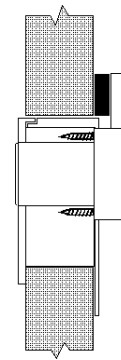

**2002LP** - Locking Handle  
**2002LPD** - Dummy handle

- Fits 3/4" to 7/8" material thickness
- Available RH or LH door and drawer

#### DRAWER LINER CONSTRUCTION

For drawer applications

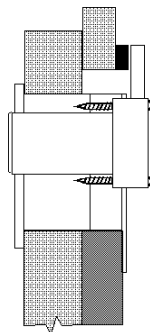

**2003LP** - Locking handle  
**2003LPD** - Dummy handle

- Fits 1-3/8" material
- Available RH door or drawer

#### HANDING



Left-hand handle with optional wire pull

Right-hand handle with optional wire pull

**FOR DRAWERS:**  
Install right- or left-hand in horizontal position

#### OVAL WIRE PULL

Positions available for 3-3/4" or 4" optional oval wire pull (required for ADA compliance).

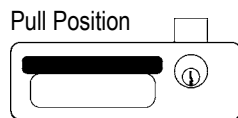

Can be used in both door or drawer applications.

Item No.	Description
102-015-96SC	3 3/4" satin chrome pull, 26D finish
102-015-96	3 3/4" polished brass pull, US3 finish
102-015-4SC	4" satin chrome pull, 26D finish
102-015-4	4" polished brass, US3 finish