

Product

2000SP Series

ADA Compatible Integrated
Handle and Cabinet Lock



U.S. Patent No.
6,412,317 B1

Meets ADA Standards*



* Meets ADA standards when
used with optional wire pull.



For 7/8" diameter, small pin
cabinet locks

"I applaud your research toward a beneficial solution to all users, including people with disabilities," and for "creating a system that would not only meet the required code and ADA standards, but would truly work the best for the widest range of users."

*Barbara L. Allan,
Director Access/Abilities Program, Easter Seals*

OVERLAY CONSTRUCTION
For door or drawer applications

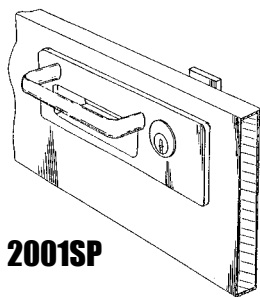

2001SP

FLUSH CONSTRUCTION
For door or drawer applica-

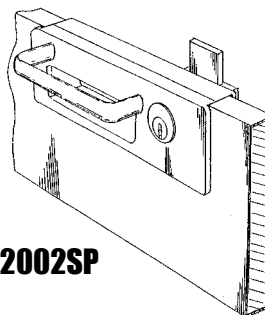

2002SP

DRAWER LINER CONSTRUCTION
For drawer applications

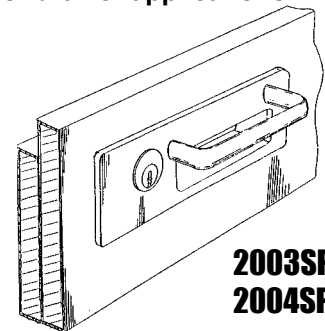

**2003SP
2004SP**

Data Sheet

OLYMPUS
LOCK, INC.

The cabinet lock innovators.

18424 Highway 99 • Lynnwood, WA 98037
Phone 206-362-3290 • Toll-free 800-525-0954 • Fax 206-362-3569
www.olympus-lock.com • info@olympus-lock.com

2000SP SERIES

ADA Compatible Integrated Handle and Cabinet Lock



General Specifications

2000SP Series Handles

- Accepts Olympus #100, #200, #500 or #600 series 7/8" diameter cabinet door and drawer locks.
- Compatible for use in ADA (American Disabilities Act) applications.
- Fits door (LH or RH) and drawer applications.
- Available in US3 or 26D finish.
- Locks available keyed alike, keyed different or custom keyed to your specifications.
- Optional camlock adapters available for use with 3/4" diameter cam locks
- Sold with optional wire pull if needed.
- Easy to install - just cut a notch or hole out of the door or drawer, insert unit, and use screws to tighten in place.
- Matching dummy handles for non-locking doors and drawers.

2000SP SMALL PIN HANDLE DIMENSIONS

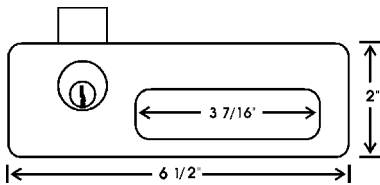

OVERLAY CONSTRUCTION

For door or drawer applications

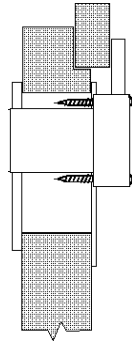

2001SP - Locking handle
2001SPD - Dummy handle

- Fits 3/4" to 1" material thickness
- Available RH or LH door and drawer

FLUSH CONSTRUCTION

For door or drawer applica-

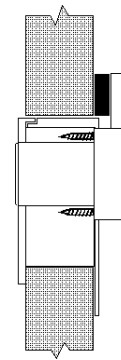

2002SP - Locking Handle
2002SPD - Dummy handle

- Fits 3/4" to 7/8" material thickness
- Available RH or LH door and drawer

DRAWER LINER CONSTRUCTION

For drawer applications

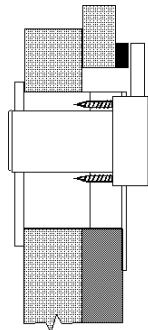

2003SP - Locking handle
2003SPD - Dummy handle
2004SP - Locking handle
2004SPD - Dummy handle

- 2003SP fits 1-1/2" material
- 2004SP fits 1-1/4" to 1-3/8" material
- Available RH door or drawer

HANDING



Left-hand handle with optional wire pull

Right-hand handle with optional wire pull

FOR DRAWERS:
Install right- or left-hand in horizontal position

CAM LOCK ADAPTERS

- For use with small pin handles only
- Zinc diecast material
- Adapters available for 3/4" Medeco or Olympus DCN or DCR cam locks

Item No.	Description
2000MED-DR	For door applications
2000MED-DW	For drawer applications

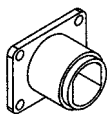

Drawer

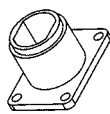

Door

OVAL WIRE PULL

Positions available for 3-3/4" or 4" optional oval wire pull (required for ADA compliance).

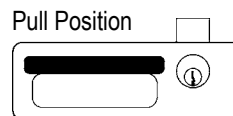

Item No.	Description
102-015-96SC	3 3/4" satin chrome pull, 26D finish
102-015-96	3 3/4" polished brass pull, US3 finish
102-015-4SC	4" satin chrome pull, 26D finish
102-015-4	4" polished brass, US3 finish



Can be used in both door or drawer applications.

